

Model 7062 RF Switch Card

Instruction Manual

Contains Operating and Servicing Information

KEITHLEY

WARRANTY

Keithley Instruments, Inc. warrants this product to be free from defects in material and workmanship for a period of 1 year from date of shipment.

Keithley Instruments, Inc. warrants the following items for 90 days from the date of shipment: probes, cables, rechargeable batteries, diskettes, and documentation.

During the warranty period, we will, at our option, either repair or replace any product that proves to be defective.

To exercise this warranty, write or call your local Keithley representative, or contact Keithley headquarters in Cleveland, Ohio. You will be given prompt assistance and return instructions. Send the product, transportation prepaid, to the indicated service facility. Repairs will be made and the product returned, transportation prepaid. Repaired or replaced products are warranted for the balance of the original warranty period, or at least 90 days.

LIMITATION OF WARRANTY

This warranty does not apply to defects resulting from product modification without Keithley's express written consent, or misuse of any product or part. This warranty also does not apply to fuses, software, non-rechargeable batteries, damage from battery leakage, or problems arising from normal wear or failure to follow instructions.

THIS WARRANTY IS IN LIEU OF ALL OTHER WARRANTIES, EXPRESSED OR IMPLIED, INCLUDING ANY IMPLIED WARRANTY OF MERCHANTABILITY OR FITNESS FOR A PARTICULAR USE. THE REMEDIES PROVIDED HEREIN ARE BUYER'S SOLE AND EXCLUSIVE REMEDIES.

NEITHER KEITHLEY INSTRUMENTS, INC. NOR ANY OF ITS EMPLOYEES SHALL BE LIABLE FOR ANY DIRECT, INDIRECT, SPECIAL, INCIDENTAL OR CONSEQUENTIAL DAMAGES ARISING OUT OF THE USE OF ITS INSTRUMENTS AND SOFTWARE EVEN IF KEITHLEY INSTRUMENTS, INC., HAS BEEN ADVISED IN ADVANCE OF THE POSSIBILITY OF SUCH DAMAGES. SUCH EXCLUDED DAMAGES SHALL INCLUDE, BUT ARE NOT LIMITED TO: COSTS OF REMOVAL AND INSTALLATION, LOSSES SUSTAINED AS THE RESULT OF INJURY TO ANY PERSON, OR DAMAGE TO PROPERTY.



Keithley Instruments, Inc. • 28775 Aurora Road • Cleveland, OH 44139 • 216-248-0400 • Fax: 216-248-6168 • <http://www.keithley.com>

CHINA: Keithley Instruments China • Yuan Chen Xin Building, Room 705 • 12 Yumin Road, Dewai, Maidian • Beijing 100029 • 8610-62022886 • Fax: 8610-62022892

FRANCE: Keithley Instruments SARL • BP 60 • 3 Allée des Carays • 91122 Palaiseau Cédex • 33-1-60-11-51-55 • Fax: 33-1-60-11-77-26

GERMANY: Keithley Instruments GmbH • Landsberger Strasse 65 • D-82110 Germering, Munich • 49-89-8493070 • Fax: 49-89-84930787

GREAT BRITAIN: Keithley Instruments, Ltd. • The Minster • 58 Portman Road • Reading, Berkshire RG30 1EA • 44-118-9575666 • Fax: 44-118-9596469

ITALY: Keithley Instruments SRL • Viale S. Gimignano 38 • 20146 Milano • 39-2-48303008 • Fax: 39-2-48302274

JAPAN: Keithley KK • Aibido Building 7F • 7-20-2 Nishishinjuku • Shinjuku-ku, Tokyo 160 • 81-3-5389-1964 • Fax: 81-3-5389-2068

NETHERLANDS: Keithley Instruments BV • Avelingen West 49 • 4202 MS Gorinchem • 31-(0)183-635333 • Fax: 31-(0)183-630821

SWITZERLAND: Keithley Instruments SA • Kriesbachstrasse 4 • 8600 Dübendorf • 41-1-8219444 • Fax: 41-1-8203081

TAIWAN: Keithley Instruments Taiwan • 1FL., 1, Min Yu First Street • Hsinchu, Taiwan, R.O.C. • 886-35-778462 • Fax: 886-35-778455

SPECIFICATIONS

MODEL 7062 RF SWITCH CARD

SWITCHES PER CARD: 2 (with isolated grounds).

CHANNELS PER SWITCH: 5.

SWITCH CONFIGURATION: 1-pole, 5 throw.

EXPANSION: A through connector is provided for cascading switches.

CONNECTOR TYPE: BNC.

RELAY DRIVE CURRENT: 100mA per channel typical.

CHARACTERISTIC IMPEDANCE: 50Ω.

TERMINATIONS: None.

PROPAGATION DELAY: <2ns typical.

	<20MHz	<250MHz	<500MHz
Insertion Loss	<0.1db	<1.0db	<3.0db
Isolation			
Channel-Channel	>75db	>60db	>55db
Switch-Switch	>80db	>65db	>60db
VSWR	1.1	1.2	1.3

MAXIMUM SIGNAL LEVEL (switched): 24V AC, DC, 50mA, 0.5VA peak (resistive load).

CONTACT LIFE: 10⁶ closures (cold switching); 10⁵ closures (at maximum signal level).

CONTACT RESISTANCE: <2Ω input to output.

CONTACT POTENTIAL: <20μV per contact.

ACTUATION TIME: 10ms (exclusive of mainframe).

RELEASE TIME: 5ms.

ENVIRONMENT,

Operating: 0° to 50°C, up to 35°C at 70% R.H.

Storage: -25°C to 65°C.

DIMENSIONS, WEIGHT: 32mm high × 114mm wide × 278mm long (1.25 in. × 4.5 in. × 11 in.). Net weight 0.54kg (1 lb, 3 oz.).

Specifications subject to change without notice.

TABLE OF CONTENTS

SECTION 1—General Information

1.1	Introduction	1
1.2	Warranty Information	1
1.3	Manual Addenda	1
1.4	Safety Symbols and Terms	2
1.5	Unpacking and Inspection	
1.6	Specifications	2

SECTION 2—OPERATION

2.1	Introduction	3
2.2	Safety Precautions	3
2.3	Wiring	3
2.3.1	1 × 5 Switch	4
2.3.2	1 of 11 Switch	6
2.4	Installation	7
2.4.1	Removal	8
2.5	Operation	8
2.6	Switch Terminology	10

SECTION 3—SERVICE INFORMATION

3.1	Introduction	13
3.2	Required Test Equipment	13
3.3	Performance Verification	14
3.3.1	Insertion Loss	14
3.3.2	Input Isolation (Channel to Channel)	15

SECTION 4—REPLACEABLE PARTS

4.1	Introduction	17
4.2	Replaceable Parts	17
4.3	Ordering Information	17
4.4	Factory Service	17
4.5	Component Layout and Schematic Diagram	17

LIST OF ILLUSTRATIONS

2-1	Simplified 7062 Diagram	5
2-2	1 of 11 Switch	7
2-3	Switch Terminology	12
3-1	Insertion Loss Test Set Up	14
4-1	Component Layout	19
4-2	Schematic Diagram	21

LIST OF TABLES

2-1	Connector/Display Relationship	9
2-2	Model 706 Connector/Channel Assignment	11
2-3	Model 705 Connector/Channel Assignment	12
3-1	Recommended Test Equipment	13
4-1	Model 7062 Replaceable Parts	18

SECTION 1

GENERAL INFORMATION

1.1 INTRODUCTION

The Model 7062 is a 50Ω RF scanner card that plugs into a mainframe scanner such as the Keithley Model 705 or Model 706. The Model 7062 incorporates two sets of 1 × 5, 1-pole switching. Each set has its own common (ground). The Model 7062 has channels which are unterminated when not connected from one channel to another. The insertion loss at 500MHz is less than 3dB. Since there are two 1 × 5 switches, each having its own common, two signals can be routed through the card simultaneously. The 1 × 5 switch can be cascaded with another 1 × 5 switch for a 1 × 10 switch with minimal loss of frequency response. There are several switching schemes that offer flexibility from the Model 7062. Refer to Section 2 Operation.

Specified relay life is greater than 100,000 closures. Cables are routed from the rear of the card. The front of the card plugs into the mainframe (e.g. Model 705 or Model 706). The mainframe operates in the matrix mode or 2-pole mode in order to control the channels. BNC connectors allow easy connection to input/output signal paths.

1.2 WARRANTY INFORMATION

Warranty information is stated on the inside front cover of this manual. If there is a need for service, contact the Keithley representative or authorized repair facility in your area. Check the back cover for addresses. The service form supplied at the end of the manual should be used to provide the repair facility with adequate information concerning any difficulty.

1.3 MANUAL ADDENDA

Improvements or changes to this manual will be explained on an addendum included with the manual. It is recommended that this information be incorporated into the appropriate places in the manual immediately.

If an additional instruction manual is required order the manual package (Keithley Part Number 7062-901-00). The manual package includes an instruction manual and all pertinent addenda.

1.4 SAFETY SYMBOLS AND TERMS

The symbol  denotes that the user should refer to the operating instructions.

The symbol  denotes that a high voltage may be present on the terminal(s).

The **WARNING** used in this manual explains dangers that could result in personal injury or death.

The **CAUTION** used in this manual explains hazards that could damage the instrument.

1.5 UNPACKING AND INSPECTION

The Model 7062 is inspected both electrically and mechanically before shipment. Upon receiving the Model 7062, unpack all items from the shipping container and check for any obvious damage that may have occurred during transit. Report any damage to the shipping agent. Retain and use the original packaging materials if reshipment is necessary. The following items are shipped with all Model 7062 orders:

Model 7062 RF Scanner Card
Model 7062 Instruction Manual

1.6 SPECIFICATIONS

For Model 7062 detailed specifications, refer to the specifications that precede this section.

SECTION 2 OPERATION

2.1 INTRODUCTION

This section provides the information necessary to use the Model 7062 with an appropriate Keithley scanner mainframe such as the Model 705 or the Model 706. Once the card is configured and placed in the appropriate slot in the scanner mainframe, refer to the scanner mainframe's instruction manual for complete operating details. This section is divided into five parts: Safety Precautions, Wiring, Installation, Operation and Switch Terminology.

2.2 SAFETY PRECAUTIONS

1. Make sure the scanner mainframe is grounded through a properly earth grounded receptacle before operation.
2. Inspect all test connections for wear and defects such as cracks, exposed wires, etc. Correct any defect found before operating the scanner card with the mainframe.
3. Do not exceed the Model 7062's maximum allowable signal level as defined in the specifications.
4. Turn off all power supplies and discharge any residual power before installing or removing the Model 7062 from the scanner mainframe.
5. Turn off all power supplies and discharge any residual power before installing or removing any wires from the Model 7062.

2.3 WIRING

Each channel on the Model 7062 consists of a single pole, Form C relay. The card can be wired for two (1 × 5), two (1 of 6), 1 × 10 or 1 of 11 configurations. Input/output connections should be made using a high quality 50Ω coaxial cable with a standard male BNC connector on the Model 7062 end. Wiring diagram nomenclature is contained on schematic diagram 7062-106 located at the end of this manual.

Cables are routed to the rear of the card while the front is plugged into the scanner mainframe (e.g. Model 705 or Model 706). The mainframe must be programmed for the matrix mode (Program 6 pole 0) or the 2-pole mode (Program 6 pole 2) to operate the channels on the

Model 7062 card. Refer to Tables 2-1 and 2-2. To configure a card for operation it must have a minimum of two connections:

1. Input
2. Output

In general:

1. The input is the signal that is switched to one of several points. The selected output is the path (channel) to which the input is switched.
2. The output is the selection of one of several sources. Any of seven inputs selected can be routed to the output for measurement or processing. The 1×5 switch has six inputs, which consist of five channel selects and a through connection. The through connector may be left open or connected to a source or terminator.

NOTE

Keep in mind that when a channel is open it is unterminated and could cause reflections.

2.3.1 1×5 Switch

With a 1×5 switch, the Model 7062 can switch any one of five channels to one output. Also, one channel can be switch to any one of five outputs. Using the through connection as a sixth channel (1 of 6), any one of six inputs can be switched to one output. Also, one input can be switched to any of six outputs. For example: Switch 1 OUT/IN can switch the signal to channels 1-1, 2-1, 3-1, 4-1 and 5-1. Also, channels 1-1, 2-1, 3-1, 4-1 or 5-1 can switch to SWITCH 1 OUT/IN. Only one channel will switch at a time on a 1×5 switch.

The Model 7062 incorporates two 1×5 switches (each with it's own separate ground) so that two signals can be switched at the same time. For example: SWITCH 1 OUT/IN can switch a signal to channels 1-1, 2-1, 3-1, 4-1 or 5-1; while SWITCH 2 OUT/IN switches another signal to channels 1-2, 2-2, 3-2, 4-2 or 5-2.

The advantage of using the 1×5 switch is that one channel will access any one of five channels. Also, any one of five channels will access one channel. With two 1×5 schemes, two separate signals can be switched at the same time. Refer to Figure 2-1.

To operate the channels (open or close) once they are configured, plug the scanner card into the scanner mainframe and consult the scanner mainframe's instruction manual for complete details.

CAUTION

Do not exceed the maximum allowable signal for the Model 7062. Instrument damage may occur.

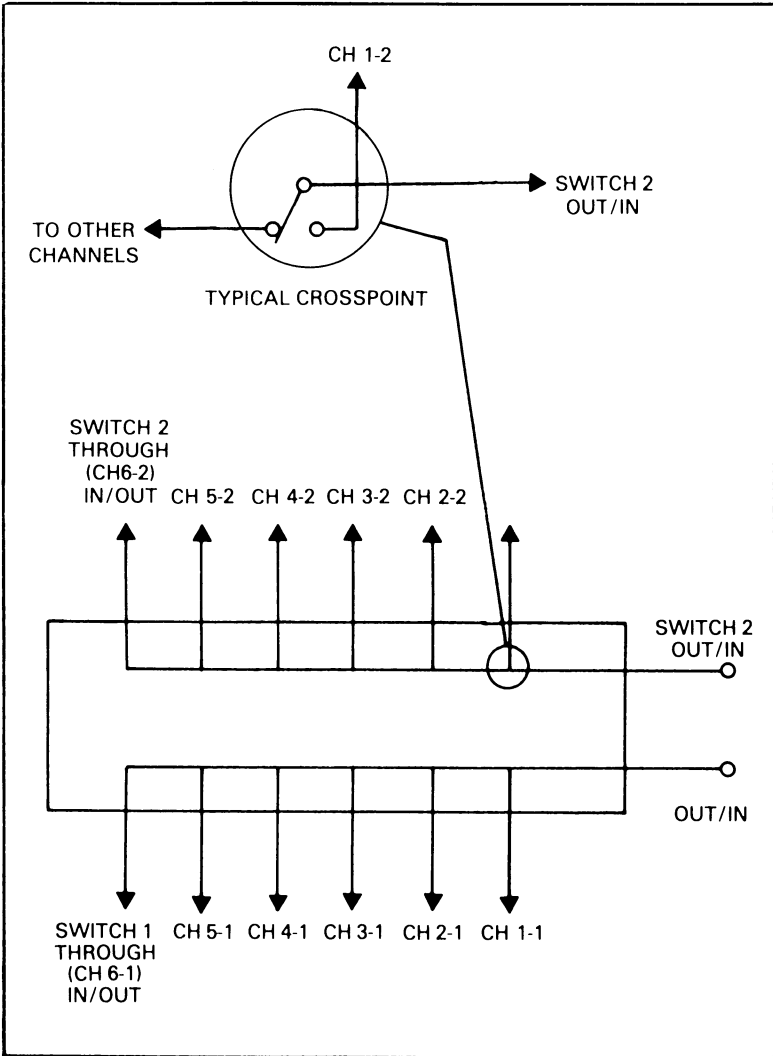

Figure 2-1. Simplified 7062 Diagram

2.3.2 1 of 11 Switch

The Model 7062 can be configured as a 1 of 11 switch. To configure the 1 of 11 switch, SWITCH 1 THROUGH (T) IN/OUT must be connected to SWITCH 2 OUT/IN (J1007 connected to J1008). Another 1 of 11 switch is SWITCH 2 THROUGH IN/OUT connected to SWITCH 1 OUT/IN (J1014 connected to J1001). In either of these configurations one channel can be switched to any one of 11 signal paths. Also, any one of 11 channels can be switched to one signal path. For example: Connect J1007 to J1008. SWITCH 1 OUT/IN will switch to any one of the following channels:

1. CH1-1
2. CH2-1
3. CH3-1
4. CH4-1
5. CH5-1
6. CH1-2
7. CH2-2
8. CH3-2
9. CH4-2
10. CH5-2
11. CH6-2 (T-2)

Refer to schematic diagram 7062-106 at the end of this manual. Refer to Figure 2-2 for a simple diagram depicting a 1 of 11 switch.

In another example, connect J1001 to J1014. In this set up SWITCH 2 OUT/IN will switch to any one of the following channels:

1. CH1-1
2. CH2-1
3. CH3-1
4. CH4-1
5. CH5-1
6. CH6-1 (T-6)
7. CH1-2
8. CH2-2
9. CH3-2
10. CH4-2
11. CH5-2

The advantage of cascading the two 1 × 5 switches is that one channel can access 11 channels instead of only one channel accessing six channels.

To operate the channels (open or close) once they are configured, plug the Model 7062 into the scanner mainframe and consult the scanner mainframe's instruction manual. The mainframe must be in the matrix mode (Program 6, pole 0) or the 2-pole (Program 6 pole 2) in order to operate the channels on the Model 7062 card.

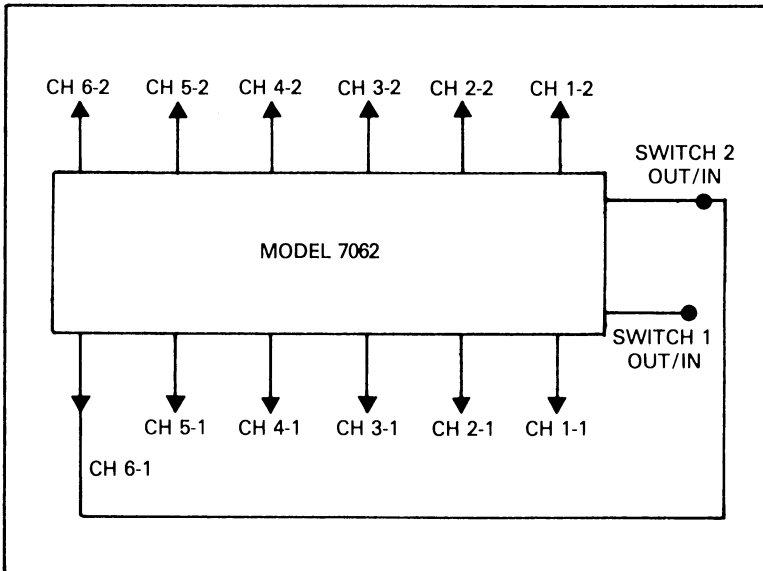

Figure 2-2. 1 of 11 Switch

2.4 INSTALLATION

WARNING

Turn off the mainframe and disconnect all other equipment from the scanner card before installing/removing the card.

Before installing the Model 7062 into the scanner mainframe, it must be wired with the desired configuration. Refer to paragraph 2.3. Once the card is configured, install it into the scanner mainframe. Plug the scanner card into the appropriate slot in the rear panel of the mainframe. In some mainframes, the scanner card is placed horizontally into the unit. The cards are labeled top or bottom. In other mainframes, the scanner cards are placed vertically into the unit and are numbered 1-10. The scanner card is placed in the mainframe with the card edge connector going in first. Align the card with the grooves in the slot and insert the card to its full depth into the mainframe. Make sure the card is properly seated into the connector in the mainframe. When the card is fully inserted, the locking tabs should be pushed toward the card to lock it in the mainframe.

NOTE

Refer to the scanner mainframe's instruction manual for complete details.

2.4.1 Removal

To remove a scanner card, first turn off the mainframe and all other equipment connected to the card. Unfasten the locking tabs on the card by pulling the tab outward. Grasp the end of the card and carefully pull it out of the mainframe.

2.5 OPERATION

Model 7062 operation consists of two parts. The two parts are:

1. Wiring the Model 7062 for the desired configuration.
2. Mainframe control of the channels.

The scanner mainframe must be in the matrix mode (Program 6, pole 0) or the 2-pole mode (Program 6 pole 2) in order to operate the channels of the Model 7062.

Table 2-1. Connector/Display Relationship

7062 Connector	Matrix Mode		2-Pole Mode	
	*Mainframe Display 706	705	†Mainframe Display 706	705
J1002	001 1	01 1	001	01
J1003	002 1	02 1	002	02
J1004	003 1	03 1	003	03
J1005	004 1	04 1	004	04
J1006	005 1	05 1	005	05
J1007	**	**	**	**
J1009	001 2	01 2	006	06
J1010	002 2	02 2	007	07
J1011	003 2	03 2	008	08
J1012	004 2	04 2	009	09
J1013	005 2	05 2	010	10
J1014	***	***	***	***

*Mainframe must be in the matrix mode (Program 6, pole 0).

Use with separate 1 × 5 switches.

**Channel 6-1 (J1007) is normally closed.

***Channel 6-2 (J1014) is normally closed.

†Mainframe must be in the 2-pole mode (Program 6, 2-pole).

Use when the card is connected as a 1 × 10 switch.

The preceding connector/channel assignment is for slot 1 of the Model 706 and the top card slot in the Model 705. More channels are available when connecting several Model 7062 cards and several mainframes together. The Model 705 has two card slots. This means that for every Model 705 a switch of 1 of 21 could be constructed. With a maximum of five Model 705s daisy chained, a switch of 1 of 101 could be constructed.

NOTE

The frequency response for the larger switching schemes is not as good as a simple 1×5 switch.

The Model 706 has 10 card slots. This means that for every Model 706 a switch of 1 of 101 could be constructed. With a maximum of five Model 706s daisy chained, a switch of 1 of 1001 could be constructed.

NOTE

Refer to the mainframe's instruction manual for information concerning daisy chain operation.

To construct such a large switching scheme, 50 Model 7062 cards and five Model 706 mainframes are required. Connections between the cards and mainframes is accomplished using the following format.

Connect card 1, CH6-1 to SWITCH 2 (J1007 to J1008). To connect one card to another, connect card 1, CH6-2 to card 2, SWITCH 1. The rest of the cards are wired in the same manner. The connector/channel assignment for the larger configurations is as follows.

2.6 SWITCH TERMINOLOGY

Throughout this manual the terminology Form C is used. The term Form C is used in switch terminology and is described as follows:

1. Form A is a single pole normally open (SPNO) switch. Refer to Figure 2-3. Example: A 2-pole switch normally open is classified as a 2 Form A.
2. Form B is similar to Form A except that its contacts are normally closed. Refer to Figure 2-3. Example: A 2-pole switch normally closed is classified as a 2 Form B.
3. Form C is shown in Figure 2-3 as a single pole double throw switch. It could also be a multiple switch such as a 2-pole. This would be classified as a 2 Form C.

Table 2-2. Model 706 Connector/Channel Assignment

*Matrix Mode					
Card #	Master	Slave #1	Slave #2	Slave #3	Slave #4
1	001-005	051-055	101-105	151-155	201-205
2	006-010	056-060	106-110	156-160	206-210
3	011-015	061-065	111-115	161-165	211-215
4	016-020	066-070	116-120	166-170	216-220
5	021-025	071-075	121-125	171-175	221-225
6	026-030	076-080	126-130	176-180	226-230
7	031-035	081-085	131-135	181-185	231-235
8	036-040	086-090	136-140	186-190	236-240
9	041-045	091-095	141-145	191-195	241-245
10	046-050	096-100	146-150	196-200	246-250
**2-Pole Mode					
1	001-010	101-110	201-210	301-310	401-410
2	011-020	111-120	211-220	311-320	411-420
3	021-030	121-130	221-230	321-330	421-430
4	031-040	131-140	231-240	331-340	431-440
5	041-050	141-150	241-250	341-350	441-450
6	051-060	151-160	251-260	351-360	451-460
7	061-070	161-170	261-270	361-370	461-470
8	071-080	171-180	271-280	371-380	471-480
9	081-090	181-190	281-290	381-390	481-490
10	091-100	191-200	291-300	391-400	491-500

In the matrix mode there are two channels for each connector/channel assignment. These are the – 1 and the – 2 channels. Refer to the schematic diagram 7062-106.

*Matrix mode must be used when using separate 1 × 5 switches.

**2-pole mode must be used when using 1 × 10 or larger switches.

Table 2-3. Model 705 Connector/Channel Assignment

*Matrix Mode					
Card #	Master	Slave #1	Slave #2	Slave #3	Slave #4
Top	01-05	11-15	21-25	31-35	41-45
Bottom	06-10	16-20	26-30	36-40	46-50
**2-Pole Mode					
Top	01-10	21-30	41-50	61-70	81-90
Bottom	11-20	31-40	51-60	71-80	91-100

In the matrix mode there are two channels for each connector/channel assignment. These are the – 1 and the – 2 channels. Refer to the schematic diagram 7062-106.

*Matrix mode must be used when using separate 1 × 5 switches.
 **2-pole mode must be used when using 1 × 10 or larger switches.

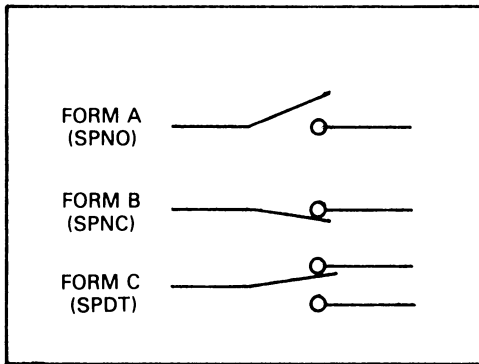

Figure 2-3. Switch Terminology

SECTION 3

SERVICING INFORMATION

3.1 INTRODUCTION

This section contains a performance verification procedure. Since there are no calibration adjustments, calibration is not necessary. Recommended maintenance includes inspection of the scanner card and the card edge connector to ensure good electrical contact. The verification procedure should be performed upon receipt of the Model 7062 or at the time maintenance is performed on the scanner mainframe.

3.2 REQUIRED TEST EQUIPMENT

Recommended test equipment for performance verification is provided in Table 3-1. Test equipment other than the recommended equipment in Table 3-1 may be substituted if specifications equal or exceed the stated characteristics.

Table 3-1. Recommended Test Equipment

Item	Description	Specification	Mfg.	Model
A	Scanner Mainframe	—	Keithley	705 or 706
B	Network Analyzer	0-1GHz	H-P	8754A
C	Transmission/ Reflection Test Set	—	H-P	8502A
D	Cable Set	— —	H-P	11851A

The performance verification procedure should be performed in an environment of 18°C—28°C and a relative humidity of less than 80%.

3.3 PERFORMANCE VERIFICATION PROCEDURE

This section gives several procedures to verify operation of Model 7062 is within specifications.

3.3.1 Insertion Loss

NOTE

For this test the operator must be familiar with operating the recommended network analyzer.

1. The equipment required for this test includes:
scanner mainframe and a network analyzer.
2. Set up the configuration shown in Figure 3-1.
3. Turn on the power to the equipment and let it warm up.
4. Calibrate the set up as described in the Model 8754A Instruction Manual.
5. Close channel CH1-1 and note the loss in dB at 20MHz, 50MHz, 250MHz and 500MHz. The loss should be less than 0.1dB at 20MHz, 0.2dB at 50MHz, 1dB at 250MHz and 3dB at 500MHz.

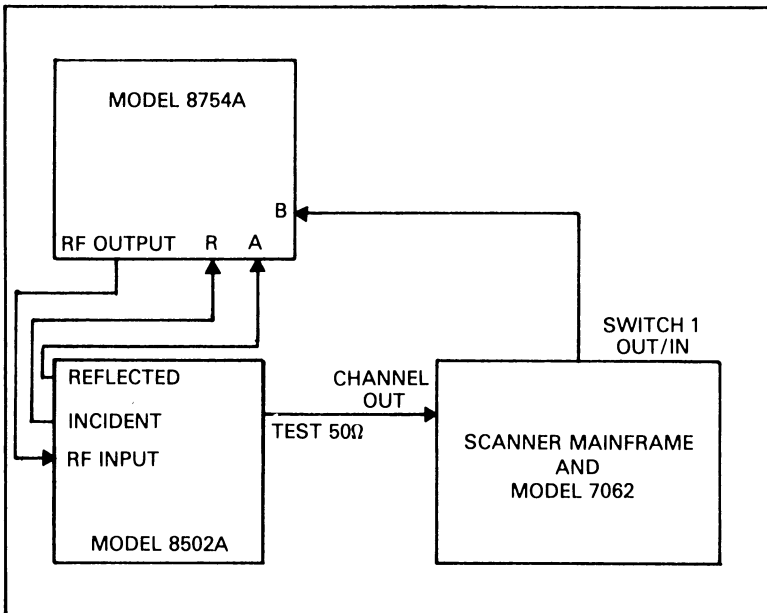

Figure 3-1. Insertion Loss Test Set Up

3.3.2 Input Isolation (Channel to Channel)

NOTE

For this test the operator must be familiar with operating the recommended network analyzer.

1. The equipment required for this test includes: scanner mainframe and a network analyzer.
2. Set up the configuration shown in Figure 3-1. Connect the 50 Ω test to CH1-1. Connect B on the Model 8754A to CH1-2.
3. Turn on the power to the equipment and let it warm up.
4. Calibrate the set up as described in the Model 8754A Instruction Manual.
5. Open the CH1-1 and note isolation at 20MHz, 50MHz and 250MHz. The isolation should be greater than 75dB at 20MHz. 60dB at 250MHz and 55dB at 500MHz.
6. Repeat step 5 for each channel on the card.

SECTION 4 REPLACEABLE PARTS

4.1 INTRODUCTION

This section contains replacement parts information, a schematic diagram and a component layout for the Model 7062.

4.2 REPLACEABLE PARTS

Parts are listed alpha-numerically in order of their circuit designation. Table 4-1 contains parts list information for the Model 7062.

4.3 ORDERING INFORMATION

To place an order or to obtain information concerning replacement parts, contact your Keithley representative or the factory. See the back cover for addresses. When ordering include the following information:

1. Instrument Model Number
2. Instrument Serial Number
3. Part Description
4. Circuit Description (if applicable)
5. Keithley Part Number

4.4 FACTORY SERVICE

If the instrument is to be returned for service, photo copy and complete the service form which follows this section and return it with the instrument.

4.5 COMPONENT LAYOUT AND SCHEMATIC DIAGRAM

Figure 4-1 contains a component layout of the Model 7062. Figure 4-2 contains a schematic diagram of the Model 7062.

Table 4-1. Model 7062 Replaceable Parts

Circuit Desig.	Description	Keithley Part No.
C101	Not Used	
C102	Capacitor, 0.1 μ F, 50V, Ceramic Film	C-237-0.1
C103	Capacitor, 0.1 μ F, 50V, Ceramic Film	C-237-0.1
C104	Capacitor, 0.1 μ F, 50V, Ceramic Film	C-237-0.1
C105	Capacitor, 10 μ F, 25V, Aluminum Electrolytic	C-314-10
J1001	Connector, BNC, right angle	CS-504
J1002	Connector, BNC, right angle	CS-504
J1003	Connector, BNC, right angle	CS-503
J1004	Connector, BNC, right angle	CS-503
J1005	Connector, BNC, right angle	CS-503
J1006	Connector, BNC, right angle	CS-503
J1007	Connector, BNC, right angle	CS-503
J1008	Connector, BNC, right angle	CS-504
J1009	Connector, BNC, right angle	CS-504
J1010	Connector, BNC, right angle	CS-503
J1011	Connector, BNC, right angle	CS-503
J1012	Connector, BNC, right angle	CS-503
J1013	Connector, BNC, right angle	CS-503
J1014	Connector, BNC, right angle	CS-503
K101	Relay	RL-180
K102	Relay	RL-180
K103	Relay	RL-180
K104	Relay	RL-180
K105	Relay	RL-180
K106	Relay	RL-180
K107	Relay	RL-180
K108	Relay	RL-180
K109	Relay	RL-180
K110	Relay	RL-180
L101	Choke	CH-16
	Handle	FA-119
	Rivet	FA-121

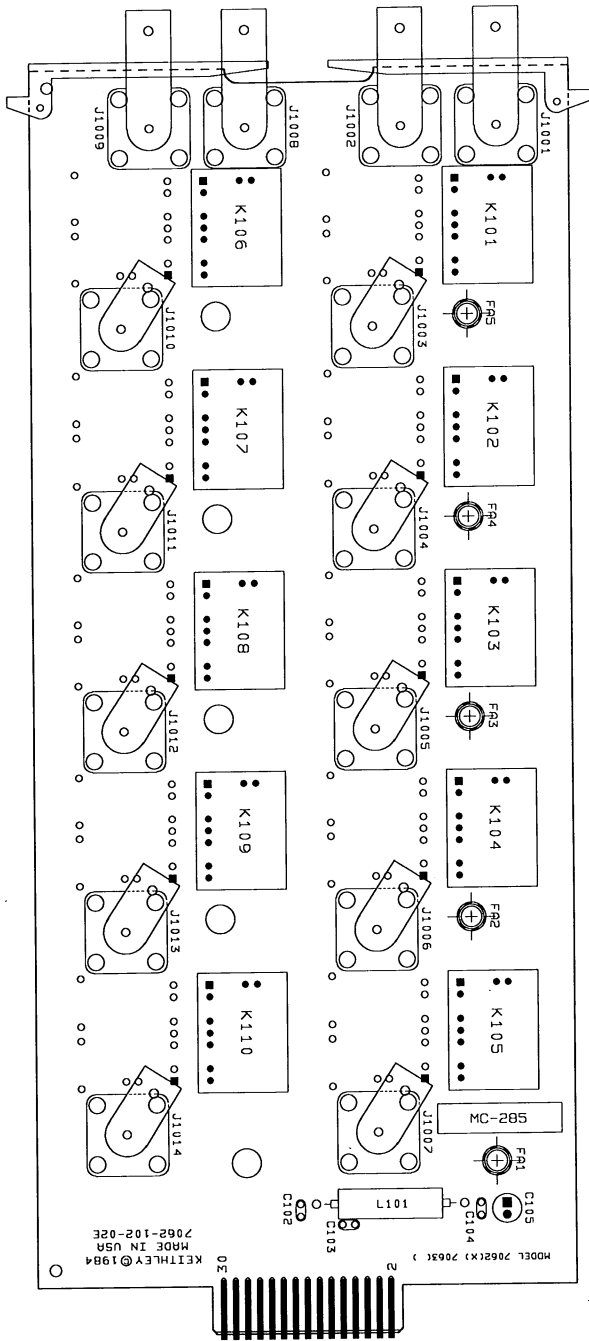

Figure 4-1. Component Layout



Service Form

Model No. _____ Serial No. _____ Date _____

Name and Telephone No. _____

Company _____

List all control settings, describe problem and check boxes that apply to problem.

- | | |
|--|--|
| <input type="checkbox"/> Intermittent | <input type="checkbox"/> All ranges or functions are bad |
| <input type="checkbox"/> IEEE failure | <input type="checkbox"/> Particular range or function bad; specify |
| <input type="checkbox"/> Front panel operational | <input type="checkbox"/> Batteries and fuses are OK |
| <input type="checkbox"/> Analog output follows display | <input type="checkbox"/> Checked all cables |
| <input type="checkbox"/> Obvious problem on power-up | |

Display or output (check one)

- | | |
|-----------------------------------|--|
| <input type="checkbox"/> Drifts | <input type="checkbox"/> Unable to zero |
| <input type="checkbox"/> Unstable | <input type="checkbox"/> Will not read applied input |
| <input type="checkbox"/> Overload | |

- | | |
|---|--|
| <input type="checkbox"/> Calibration only | <input type="checkbox"/> Certificate of calibration required |
| <input type="checkbox"/> Data required | |

(attach any additional sheets as necessary)

Show a block diagram of your measurement system including all instruments connected (whether power is turned on or not). Also, describe signal source.

Where is the measurement being performed? (factory, controlled laboratory, out-of-doors, etc.)

What power line voltage is used? _____ Ambient temperature? _____ °F

Relative humidity? _____ Other? _____

Any additional information. (If special modifications have been made by the user, please describe.) _____

Be sure to include your name and phone number on this service form.

KEITHLEY

Keithley Instruments, Inc.
Test Instrumentation Group

28775 Aurora Road
Cleveland, Ohio 44139

Printed in the U.S.A.